

TECHNICAL DATA

ROLF BENZ RONDO



**ROLF
BENZ**

- Wooden inner frame
- Nosag spring support
- Back pad in polyurethane foam
- Back cover quilted underneath with polyester nonwoven

„Lounge Deluxe“

- Seat made of high-quality cold foam, built up in coordinated layers, covered with a mat consisting of 20% viscose foam and 80% microfibres and a non-woven polyester cover

„Lounge Plus“

- Seat made from layers of high quality cold foam with several variations in thickness and hardness available, with a polyester fleece cover
- Downy-soft back cushions worked into ticking chambers with a filling of 100% microfibres
- Seat height options 42 cm or 45 cm
- Choice of bases:
 - Cast aluminium base, polished
 - Cast aluminium base, painted, RAL 9017 traffic black
 - Cast aluminium base, painted, RAL 7022 umbra grey

! Due to the way the furniture is designed, and its comfort level, some wrinkles and sitting pressure indentations are inevitable, even in top quality Rolf Benz upholstered furniture. All dimensions are approximate.



Lounge Deluxe



Lounge Plus

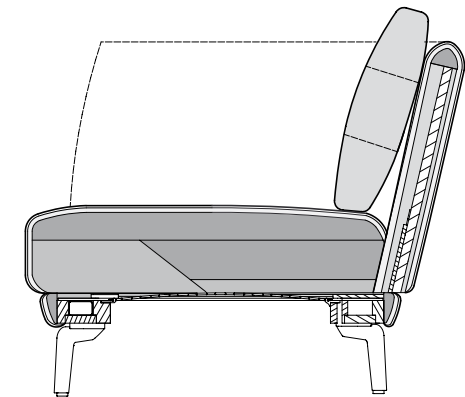
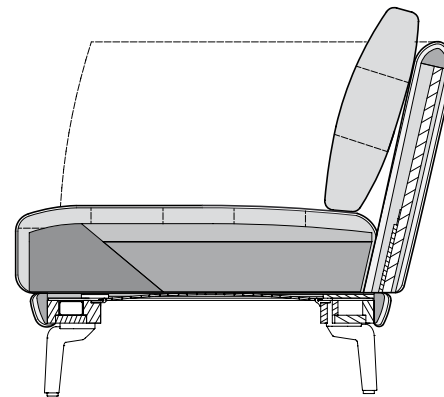

Seat heights available

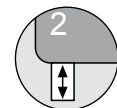

Sofa

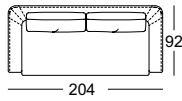

Sectional sofa*

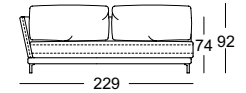
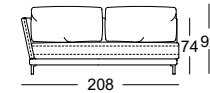
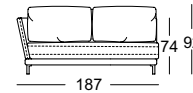
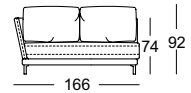
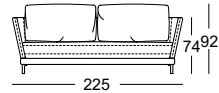
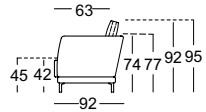

Outsize sectional sofa*

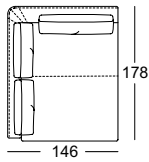

Corner modular sofa element*



Corner sectional sofa weith fixed footstool*

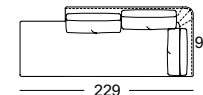

Upholstered bench element*

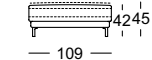
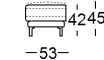
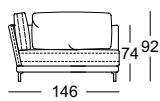
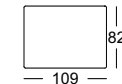

Low back cushion



Back cushion mat



Headrest

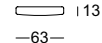

*These elements are only shown in the left version. They are also available in the right version.

Combination examples:

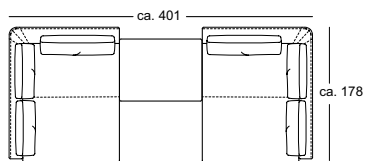

K-XL-ASO 525/146 le.
 RUK-SET-XL-ASO 525/146 le.
 PB 525/109
 K-XL_ASO 525/146 ri.
 RUK-SET-XL-ASO 525/146 ri.

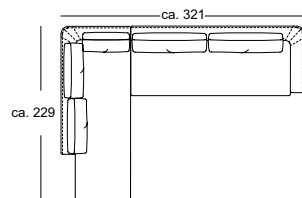

K-E-ARB-PSZ- 525/229 le.
 RUK-SET-E-ARB 525/229
 K-ASO 525/229 ri.
 RUK-SET-ASO 525/229

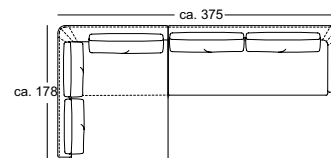

K-XL-ASO 525/146 le.
 RUK-SET-XL-ASP 525/146 le.
 K-ASO 525/229 ri.
 RUK-SET-ASO 525/229

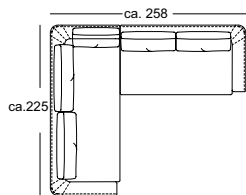

K-E-ASO 525/225 le.
 RUK-SET-E-ASO 525/225 le.
 K-ASO 525/166 re.
 RUK-SET-ASO 525/166